

BRINGING FUNCTIONALITY TO LIGHT

Whether you need shelf lighting, under cabinet lighting, energy efficiency or the special effects available only with our new FT and AGA LED lighting units.

Agabekov offers a full spectrum of interior lighting products and accessories to bring illumination to all types of residential and commercial applications.

Please contact us for more informations.

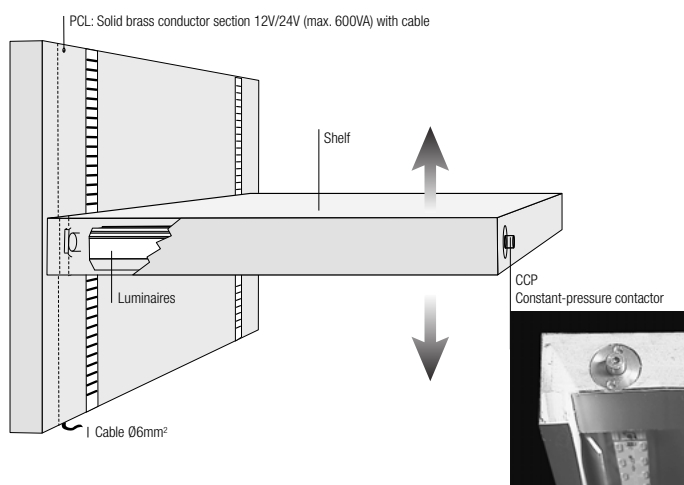
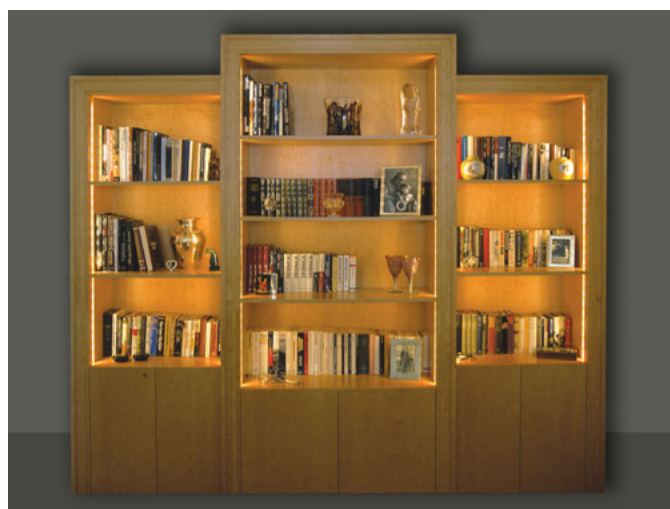

	Led Festoon Series			
	FT-21		FT-31	
Connector	Festoon		Festoon	
Led per unit	2		3	
Input Voltage (V)	24V		24V	
Power (W)	0.5W		1.1W	
Color T° (K)	2300-2600K	2600-3000K	2300-2600	2800-3200
CRI	75	70	75	80
Luminous Flux (lm)	16 - 18 lm	19 - 21 lm	37 - 54 lm	41 - 61 lm
Beam Angle (°)	120°		120°	
Dimensions (mm)	42 x 12 x 9		42 x 12 x 9	
Operating T°	-20°C / + 45°C			
Lifetime	25'000h			
Warranty	2 years			



Source type:

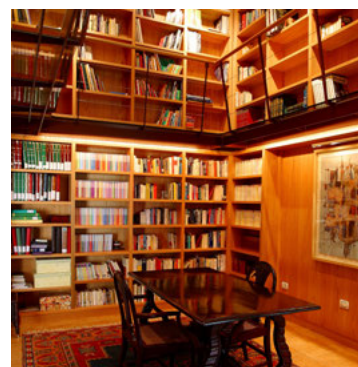
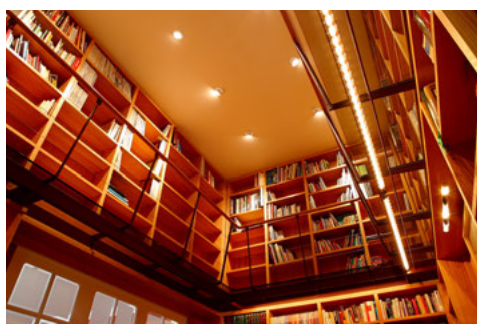
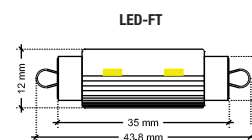
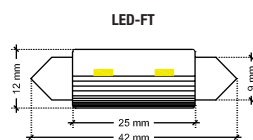
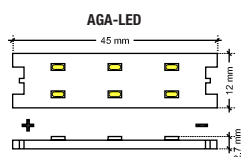
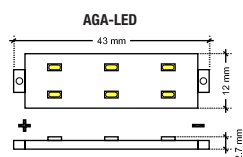

distributed by
WWW.L-E-D.COM
 +43 512 378737



STATE MOSQUE OF QATAR

Doha, Qatar

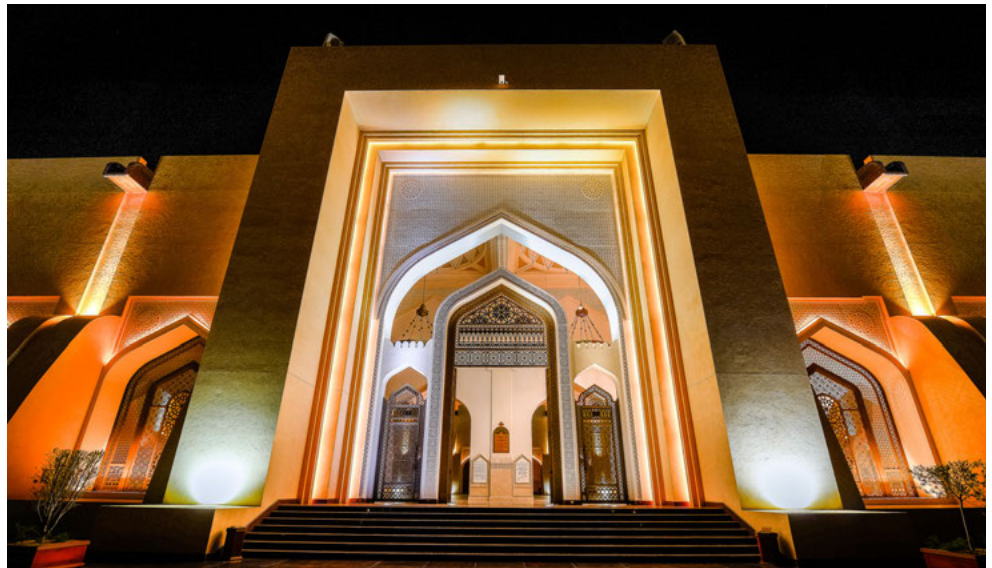

Project Management: Arab Engineering Bureau
Consultant: SMEC International Pty Ltd.
Design Consultant: Mimar Consult
Lighting Design: Architectural Lighting Design SHLD. Mr. Sabry El Harrany
Contractor: Contraco
Lighting Supplier: Lumatron Qatar wll.
Technical support and concept: AGABEKOV SA
Luminaries manufactured on measure by AGABEKOV SA on the base of B'Light® conductor.

Type of Luminaries AGABEKOV:
LFX - 1'000mm to 2'000mm x 3'036 units
LU4EX - 400mm to 2'033mm x 732 units
LU4AL - 0470mm x 202 units
LASY AC - 0550mm to 2'380mm x 63 units
Xenon Rigid Loop Lamp 24V 5W x 81'949 units
Xenon Rigid Loop Lamp 12V 8.5W x 2'604 units
AGA-LED® 24V 1.1W B10 - 2'800°K x 1'616 units

AGABEKOV
LIGHTING COMPANY INTERNATIONAL®

distributed by
WWW.L-E-D.COM
+43 512 378737



AGABEKOV *Selection*

The ideal solution for bathroom lighting with LED, Xenon and Florescent

1. AML Mirror Lighting

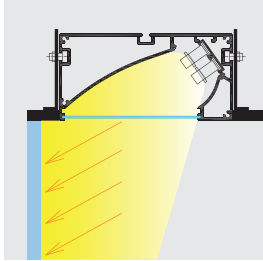

- Asymmetric reflector for diffused light
- No shade on the face
- No dazzling
- Double track for high light intensity
- Large choice of lighting source

2. SPOT 70 SERIES "IMP WET" - Round or Square - IP54

500lm/700lm/1000lm/1300lm CRI 80+
400lm/700lm CRI 98

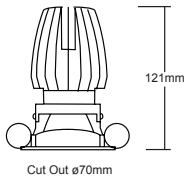

- Small recessed sealed downlight
- IP54 to ceiling for wet room applications
- Die-cast construction
- Supplied with pre-wired remote non-dimming driver
- Glare control and baffle accessories
- Small cut out for halogen replacement

3. INDOOR LINEAR FLEX - LFALC - 4 POSITIONS

Cornice lighting: with LF Clip, to distribute the light in 4 Positions.

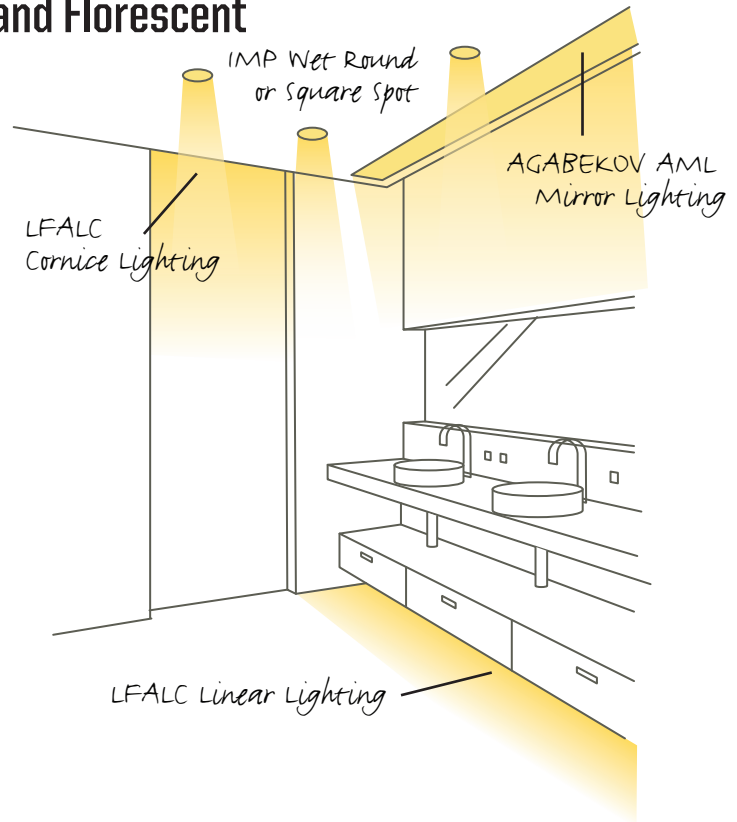
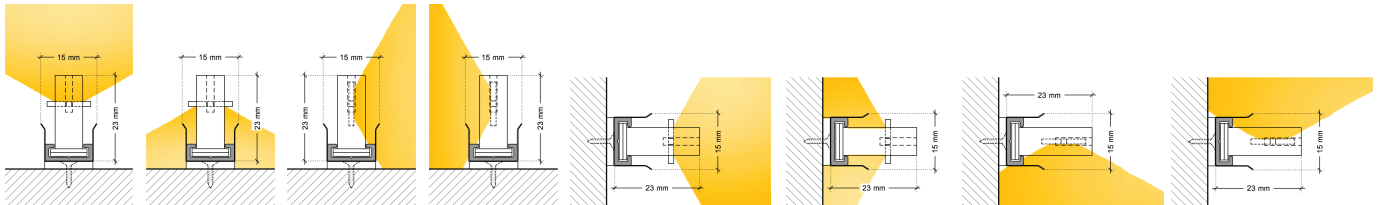

Please contact us for more details



distributed by
WWW.L-E-D.COM
+43 512 378737



WARDROBE CLOSET LIGHTING SYSTEMS IDEAL FOR HOTELS, PRIVATE HOUSES, YACHTS, ETC



Advantages: on measure up to 3 meters, low energy consumption (max. 20.4W per meter), 12V or 24V, no heat, warm color temperature 2300K°, different type of finishing (Plywood, RAL, Chromium, Bronze, etc.).

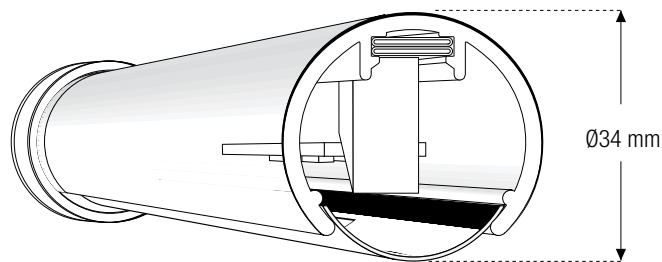

LPALW AGA-LED® B-6 RIGID LOOP CONNECTOR 24V / 0.5W / 1.2W / 2800K°, 5000K°

Power and other data - Daten und Leistungen - Données et puissances

Ref.	Length	N° of lighting units	Volts	Power
LPALW-0330	330 mm	5	24V	6 W
LPALW-1000	1000 mm	17	24V	20.40 W
LPALW-1670	1670 mm	29	24V	34.80 W

fabriqué sur mesure - prix sur demande / Massanfertigung - Preise auf Anfrage / made to measure - price on request

Source type: AGA-LED (B6 or B4), FTR LED or XENON
2300K°. 2400K°. 2800K° and 4000K°

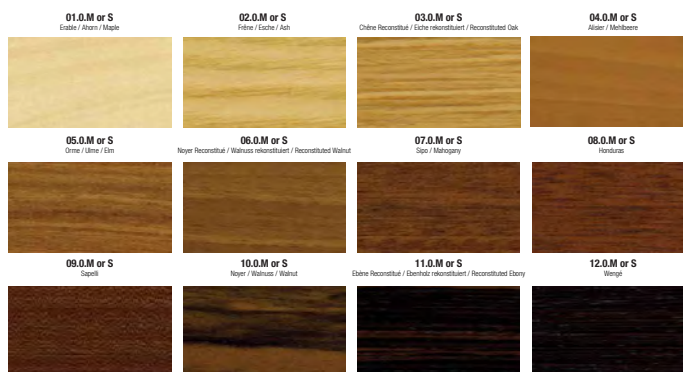
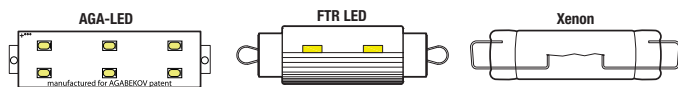

For more information don't hesitate to contact us: info@agabekov.com or www.agabekov.com

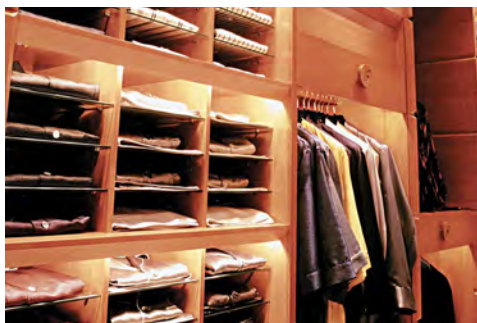

distributed by
WWW.L-E-D.COM
+43 512 378737



THE CATHEDRAL TREASURY OF DUBROVNIK

Riznica Katedrale, Dubrovnik, Croatia

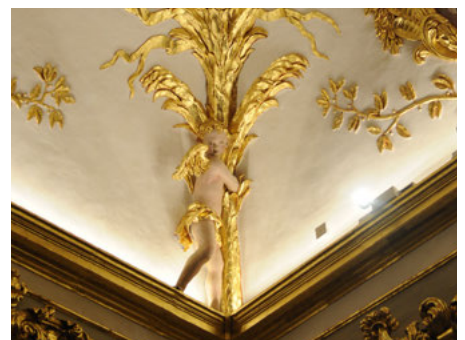

Building: Dubrovnik Cathedral
Dubrovnik Cathedral Treasury
Light design: Antun Stedul dipl. ing. Spekto d.o.o.
Technical support and lighting on measure by AGABEKOV SA

Luminaires
Agabekov Linear lighting:
13pcs x LL3AL AGA-LED Louvre 3 24V/1.2W 2400K
4 pcs x LU4CSAL AGA-LED LU4C 24V/1.2W 2400K

AGABEKOV
LIGHTING COMPANY INTERNATIONAL®



distributed by
WWW.L-E-D.COM
+43 512 378737



AGABEKOV *Selection* CHALETS



UP-CL23-60 10W

Certification



Technical Information

Dimensions: Ø80 x Ht. 48mm.
Cut out: Ø60 - 70mm.



UP-DL15 13W

Certification



Technical Information

Dimensions: Ø102 x Ht. 38mm.
Cut out: Ø90 - 95mm.



AGA-LED® CLIP-4 POSITIONS

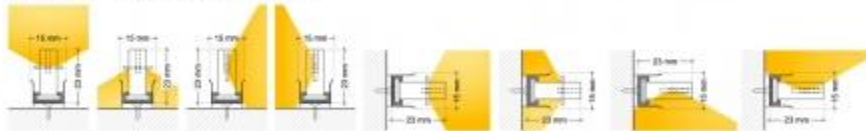

LASYT IP65/68

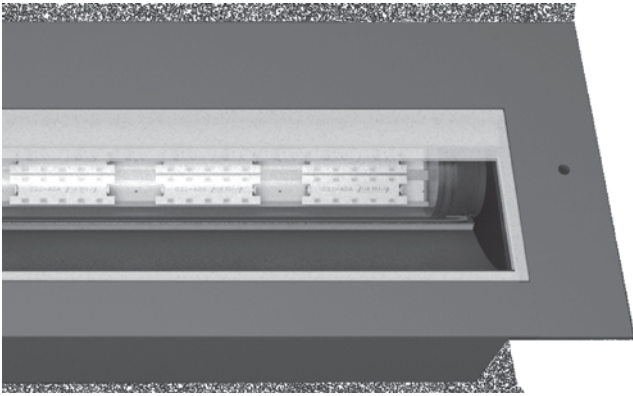

New High End recessed IP68 luminaire with AGA-LED single and double track for stronger light output 24V / 2400K°, 2800K°, and 4000K°

Advantages

- Asymmetric reflector with multiple light sources
- Uniform light output
- Profil is IP65, Tube is IP68 to protect light sources against condensation
- Custom made till 2 meters
- Single and double Aga-Led tracks
- Finishing: any RAL color

Please contact us for more details

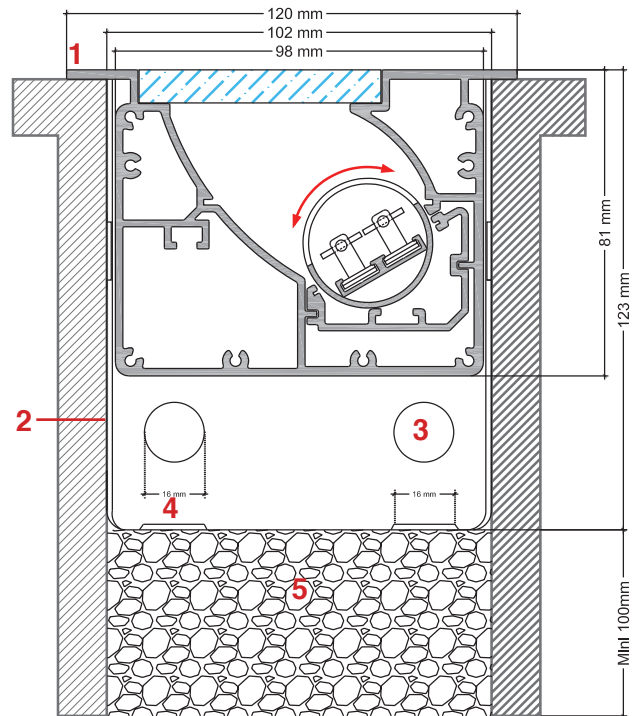

For easy installation of LASY asymmetric luminaire in the ground, respect the following instructions.

IMPORTANT: It is essential to provide drainage when installing the luminaire in the ground

1. Ground recessed luminaire
2. Stainless steel box
3. Space for electrical tube $\varnothing 16\text{mm}$
4. Drain $\varnothing 16\text{mm}$ for water evacuation
5. Drainage : mini 100mm

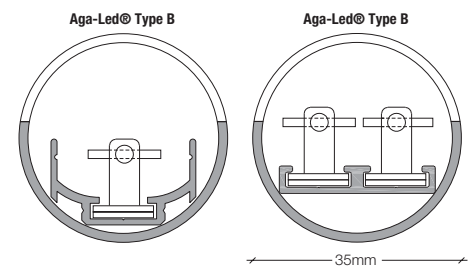
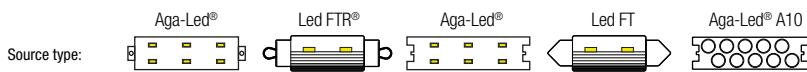

ESZTERGOM BASILICA ILLUMINATION

Esztergom, Hungary

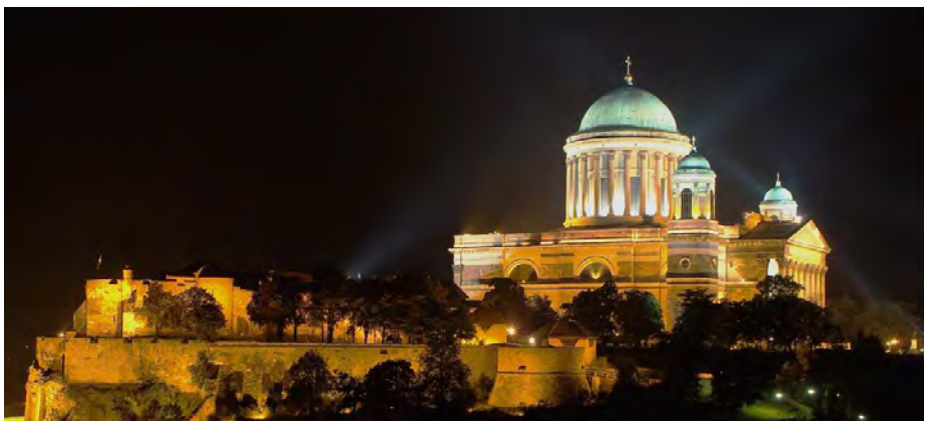

Illumination study, plan and installation made by LISYS Lighting Systems PLC.

Lighting designer: Laszlo Deme (technical director)

Installation works: Laszlo Farkas (project chief engineer)

Photo: Dezso Tanka

Other manufacturer's product in the illumination:

- Philips Arenavision (cupola lighting, largest distance 190 m)
- Schröder TERRA (light up 30m high facades) and NEOS families
- Willy MEYER+Sohn SUPERLIGHT Compact series

The AGABEKOV LLN luminaires are installed in the tympanon and above the cornice

LLN-0980 (26 V, 8,5 W) x 14 pcs

LLN-1475 (26 V, 8,5 W) x 12 pcs

LLN-1970 (26 V, 8,5 W) x 171 pcs

For more information don't hesitate to contact us: info@agabekov.com
or www.agabekov.com



distributed by
WWW.L-E-D.COM
+43 512 378737

